

# MEASURED SURVEY AND D/19 FORM FILING

PLEASE SPECIFY THE DIMENSIONS, THE DOOR OPENING DIRECTION (LH OR RH) AND THE INSTALLATION TYPE (FREE-STANDING OR FLOOR LEVEL)

**DISENIA**<sup>®</sup>  
ARCHITECTURAL SHOWERS

**DISENIA S.R.L.**  
Via A. Carpenè, 21 - 33070 - Maron di Brugnera (PN)  
Tel. +39 0434 613643 - Fax + 39 0422 742067  
www.disenia.it ideagroup@ideagroup.it export@ideagroup.it

Date ..... Model ..... Dealer .....  
Note ..... Installer .....

**WE RECOMMEND ATTACHING  
A PHOTO OF THE SHOWER SPACE**

**LH** EXT.  
OPENING DIRECTION

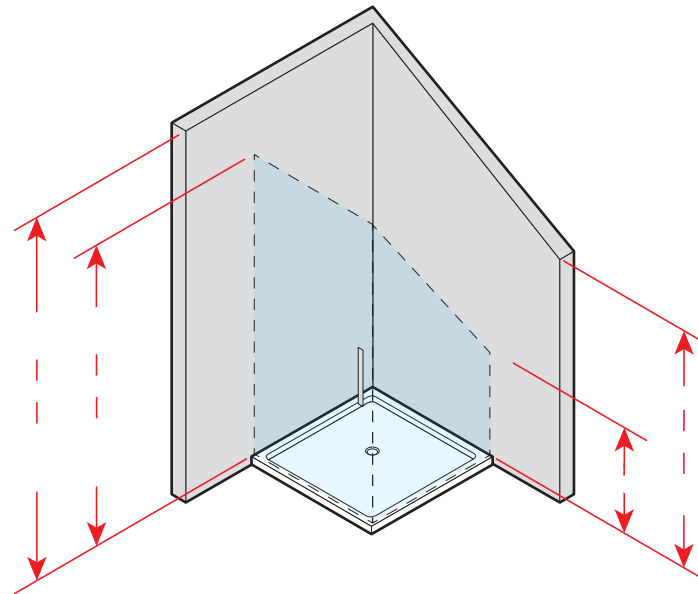
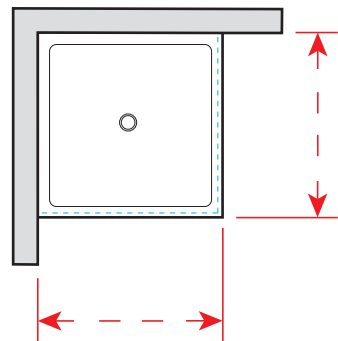

**RH** EXT.  
OPENING DIRECTION

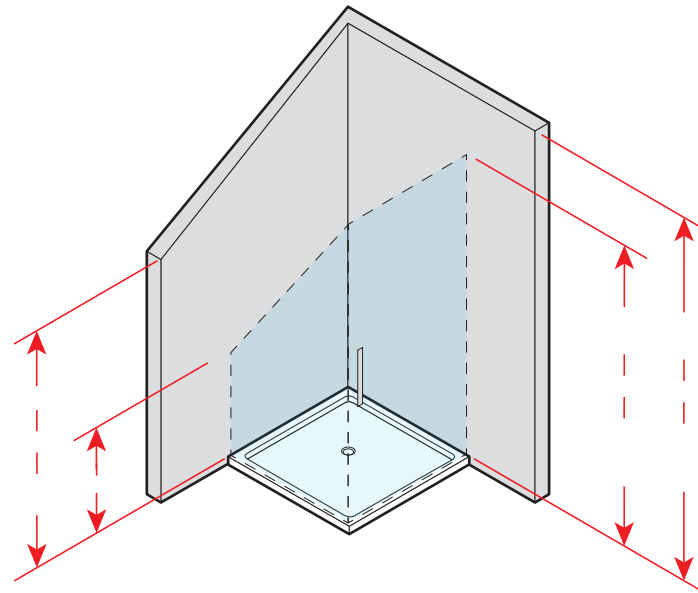
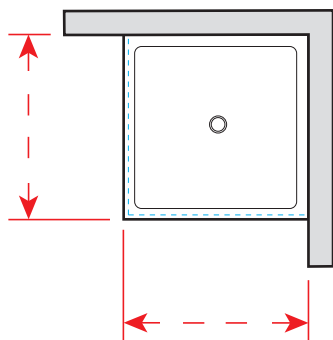

## ON A TRAY

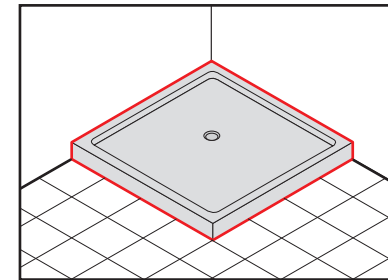

STANDARD INSTALLATION

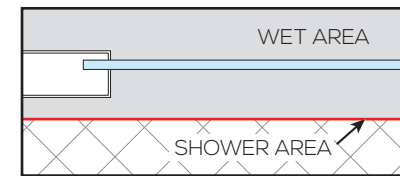

## FLOOR LEVEL

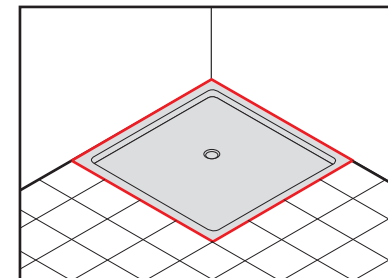

PROFILE INSTALLATION  
ON THE INSIDE



PROFILE INSTALLATION  
ON THE OUTSIDE



GLASS INSTALLATION  
ON THE INSIDE



GLASS INSTALLATION  
OUT OF THE GROUT LINE



GLASS INSTALLATION  
ON THE GROUT LINE

