

OVAL MINI CON PANNELLATURA

**PILETTA
E SIFONE
INCLUSI**

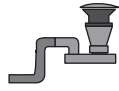

PILETTA: UP & DOWN - IN TINTA
CAPACITÀ AL TROPPO PIENO: 230 LITRI
PORTATA SCARICO: 40 lt / min
REGOLAZIONE PIEDINI: 10 mm

ARTICOLI

OVALM1L

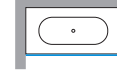

OVALM2L

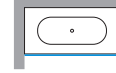

OVALM3L



OVALM4L

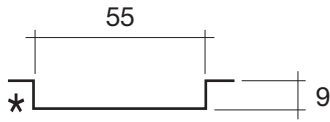
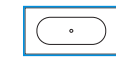

Dimensioni Minime

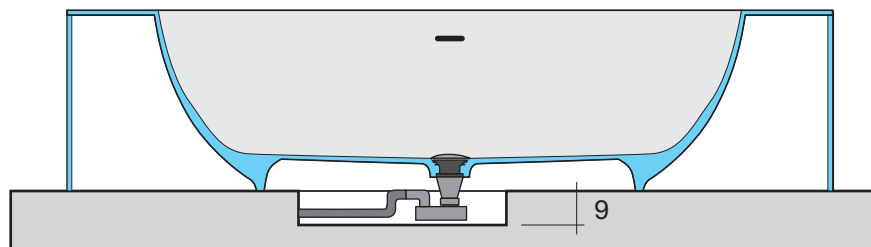
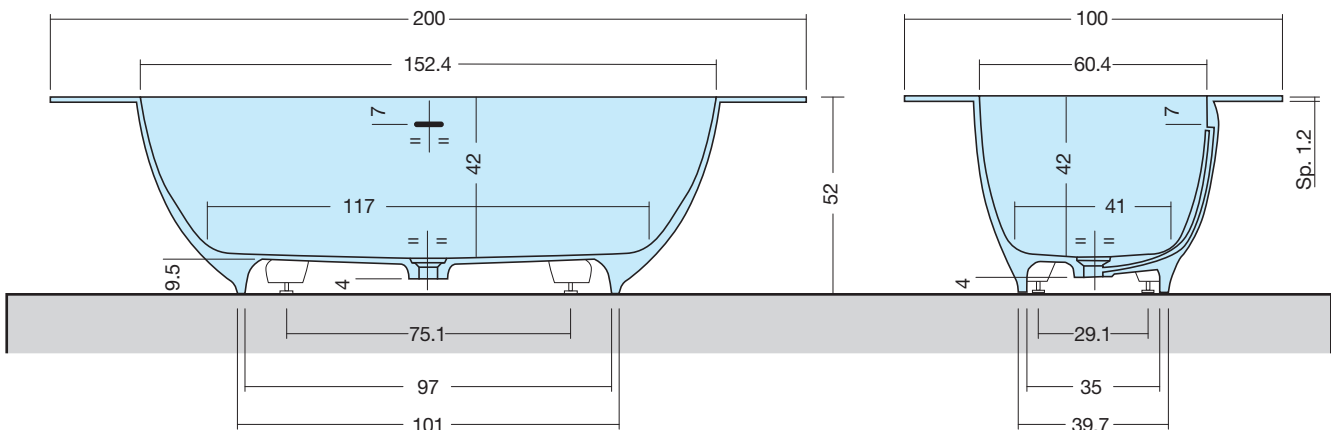
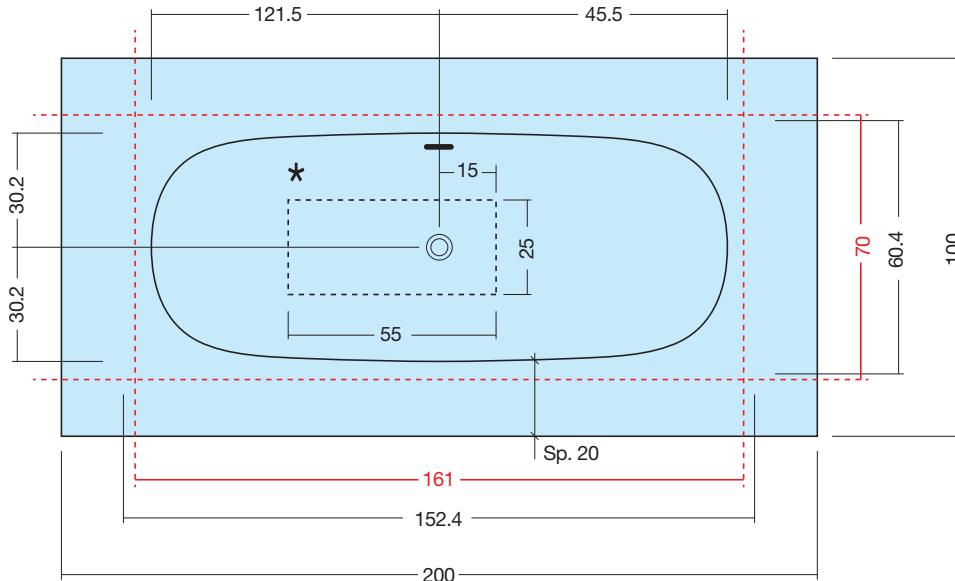

DISENIA[®]
 ARCHITECTURAL SHOWERS

DISENIA SRL Via Antonio Carpenè, 21 - 33070 Brugnera (PN) - Italy
 T. (+39) 0422 742242 - www.disenia.it - info@disenia.it